



6U SuperBlade Systems®

SBE-614E



SBE-610J



User's Manual

Revision 1.0

The information in this User's Manual has been carefully reviewed and is believed to be accurate. The vendor assumes no responsibility for any inaccuracies that may be contained in this document, and makes no commitment to update or to keep current the information in this manual, or to notify any person or organization of the updates. **Please Note: For the most up-to-date version of this manual, please see our website at www.supermicro.com.**

Super Micro Computer, Inc. ("Supermicro") reserves the right to make changes to the product described in this manual at any time and without notice. This product, including software and documentation, is the property of Supermicro and/or its licensors, and is supplied only under a license. Any use or reproduction of this product is not allowed, except as expressly permitted by the terms of said license.

IN NO EVENT WILL Super Micro Computer, Inc. BE LIABLE FOR DIRECT, INDIRECT, SPECIAL, INCIDENTAL, SPECULATIVE OR CONSEQUENTIAL DAMAGES ARISING FROM THE USE OR INABILITY TO USE THIS PRODUCT OR DOCUMENTATION, EVEN IF ADVISED OF THE POSSIBILITY OF SUCH DAMAGES. IN PARTICULAR, SUPER MICRO COMPUTER, INC. SHALL NOT HAVE LIABILITY FOR ANY HARDWARE, SOFTWARE, OR DATA STORED OR USED WITH THE PRODUCT, INCLUDING THE COSTS OF REPAIRING, REPLACING, INTEGRATING, INSTALLING OR RECOVERING SUCH HARDWARE, SOFTWARE, OR DATA.

Any disputes arising between manufacturer and customer shall be governed by the laws of Santa Clara County in the State of California, USA. The State of California, County of Santa Clara shall be the exclusive venue for the resolution of any such disputes. Supermicro's total liability for all claims will not exceed the price paid for the hardware product.

FCC Statement: This equipment has been tested and found to comply with the limits for a Class B digital device pursuant to Part 15 of the FCC Rules. These limits are designed to provide reasonable protection against harmful interference when the equipment is operated in a commercial environment. This equipment generates, uses, and can radiate radio frequency energy and, if not installed and used in accordance with the manufacturer's instruction manual, may cause harmful interference with radio communications. Operation of this equipment in a residential area is likely to cause harmful interference, in which case you will be required to correct the interference at your own expense.

California Best Management Practices Regulations for Perchlorate Materials: This Perchlorate warning applies only to products containing CR (Manganese Dioxide) Lithium coin cells. "Perchlorate Material-special handling may apply. See www.dtsc.ca.gov/hazardouswaste/perchlorate".



WARNING: This product can expose you to chemicals including lead, known to the State of California to cause cancer and birth defects or other reproductive harm. For more information, go to www.P65Warnings.ca.gov.

Manual Revision 1.0

Release Date: April 30, 2018

Unless you request and receive written permission from Super Micro Computer, Inc., you may not copy any part of this document. Information in this document is subject to change without notice. Other products and companies referred to herein are trademarks or registered trademarks of their respective companies or mark holders.

Copyright © 2018 by Super Micro Computer, Inc.
All rights reserved.

Printed in the United States of America

Preface

About this Manual

This manual is written for professional system integrators, Information Technology professionals, service personnel and technicians. It provides information for the installation and use of Supermicro's 6U SuperBlade system. Installation and maintenance should be performed by experienced professionals only.

Manual Organization

Chapter 1: Introduction

The first chapter provides a checklist of the main components included with the blade system and describes the main features of the mainboard and enclosure. A quick start procedure is also provided for your use.

Chapter 2: System Safety

You should familiarize yourself with this chapter for a general overview of safety precautions that should be followed when installing and servicing the 6U SuperBlade.

Chapter 3: Setup and Installation

Refer here for details on installing the 6U SuperBlade system into a rack.

Chapter 4: System Modules

This chapter covers modules in the 6U SuperBlade system, as well as the CMM module.

Chapter 5: Power Supply Modules

This chapter covers the system power supplies and their installation.

Appendix A: System Specifications

This appendix provides a summary of system specifications.

Table of Contents

Chapter 1 Introduction	1-1
1-1 Overview.....	1-1
1-2 Quick Start Setup.....	1-1
1-3 Software Mode Selection.....	1-2
1-4 Product Checklist of Typical Components.....	1-3
1-5 Blade Enclosure Features.....	1-5
Power.....	1-6
Middle Plane.....	1-6
LEDs.....	1-7
Enclosure Cooling.....	1-7
1-6 Power Supply Features.....	1-7
Power Supply Modules.....	1-9
Power Cord.....	1-9
Power Supply Failure.....	1-9
1-7 Special Design Features.....	1-9
Operating System Support.....	1-9
Remote Management.....	1-10
Computing Density/Power.....	1-10
High-Efficiency Power Supplies.....	1-10
1-8 Returning Merchandise for Service.....	1-10
1-9 Contacting Supermicro.....	1-11
Chapter 2 Standardized Warning Statements	2-1
2-1 About Standardized Warning Statements.....	2-1
Warning Definition.....	2-1
Installation Instructions.....	2-3
Circuit Breaker.....	2-4
Power Disconnection Warning.....	2-5
Equipment Installation.....	2-6
Restricted Area.....	2-7
Battery Handling.....	2-9
Redundant Power Supplies.....	2-10
Backplane Voltage.....	2-11
Comply with Local and National Electrical Codes.....	2-12
Product Disposal.....	2-13
Hot Swap Fan Warning.....	2-14

Power Cable and AC Adapter	2-15
Chapter 3 Setup and Installation	3-1
3-1 Overview	3-1
3-2 Unpacking the System	3-1
Choosing a Setup Location	3-1
Rack Precautions	3-2
Server Precautions	3-2
Rack Mounting Considerations	3-2
Ambient Operating Temperature	3-2
Reduced Airflow	3-2
Mechanical Loading	3-2
Circuit Overloading	3-3
Reliable Ground	3-3
Installing the System Into a Rack	3-3
Rack Mounting Hardware	3-3
Installation	3-4
Chapter 4 System Modules	4-1
4-1 Chassis Management Module	4-3
Module Redundancy	4-5
Determining Master/Slave Modules Status	4-5
CMM Module Installation	4-5
Configuring the CMM	4-6
CMM Functions	4-9
Remote KVM over IP	4-9
Remote Storage (Virtual Media)	4-9
Serial Over LAN (SOL)	4-9
Monitoring Functions	4-9
Power Consumption Management	4-10
USB Ports and Reset Button	4-11
USB Ports	4-11
Reset Button	4-12
Firmware	4-12
Web-based Management Utility	4-12
Supported Browsers	4-13
Network Connection/Login	4-13
Address Defaults	4-13
Home Page	4-14

Chapter 5 Power Supply Modules	5-1
5-1 Power Supply Modules.....	5-1
Power Supply Failure.....	5-4
Installing a Power Supply.....	5-4
Removing a Power Supply.....	5-4
5-2 Redundant Power Supplies	5-5
5-3 Power Supply Fans.....	5-6
Appendix A System Specifications	A-1
A-1 Enclosure Specifications	A-1
A-2 Environmental Specifications.....	A-2
A-3 Address Defaults.....	A-2
A-4 Power Supply Power Calculations.....	A-3

List of Figures

Figure 3-1. Positioning the Enclosure Template	3-4
Figure 3-2. Securing the Rails to the Rack	3-4
Figure 3-3. Attaching the Optional Handles	3-5
Figure 3-4. Enclosure Installed into Rack	3-5
Figure 4-1. 6U SBE-614E Enclosure Rear View	4-1
Figure 4-2. 6U SBE-610J Enclosure Rear View	4-2
Figure 4-3. Chassis Management Module MBM-CMM-FIO	4-3
Figure 4-4. Chassis Management Module MBM-CMM-001	4-4
Figure 4-5. Choose Internal Protocol	4-7
Figure 4-6. Manually Configure the IP Address	4-7
Figure 4-7. Changing Settings	4-8
Figure 4-8. USB Ports on CMM	4-11
Figure 4-9. Home Page	4-14
Figure 5-1. PWS-2K21A-BR Power Supply	5-2
Figure 5-2. PWS-1K20B-BR Battery Backup Power Module	5-3
Figure 5-3. Power Supply Status	5-5

List of Tables

Table 1-1. Networking Module Solutions	1-4
Table 1-2. 6U SuperBlade Enclosures	1-5
Table 1-3. Number of Network Modules that May Be Installed in each Enclosure	1-6
Table 1-4. Enclosure Models and Power Supply Combinations	1-8
Table 1-5. Model Power Supply Populations	1-8
Table 4-1. Typical 6U Blade System Module Configuration: Rear View	4-1
Table 4-2. Typical 6U Blade System Module Configuration: Rear View	4-2
Table 4-3. MBM-CMM-FIO Module Interface	4-3
Table 4-4. MBM-CMM-FIO Module Features	4-4
Table 4-5. MBM-CMM-001 Module Interface	4-4
Table 4-6. MBM-CMM-001 Module Features	4-5
Table 4-7. CMM Reset Settings	4-12
Table 4-8. Address Defaults	4-13
Table 5-1. Amperage Draw Specifications for the PWS-2K21A-BR Power Supply	5-1
Table 5-2. PWS-2K21A-BR Power Supply Features	5-2
Table 5-3. PWS-1K20B-BR Battery Backup Power (BBP) Module Specifications	5-3
Table 5-4. PWS-1K20B-BR BBP Module Estimated Runtime	5-4
Table 5-5. Chassis Compatible with the BBP	5-4
Table A-1. 6U Enclosure Specification Features	A-1
Table A-2. Environmental Specification Features	A-2
Table A-3. Address Defaults	A-2
Table A-4. Power Supply: Power Calculations (PWS-2K21A-BR)	A-3
Table A-5. Power Supply: Power Calculations (PWS-1K20B-BR)	A-3

Chapter 1

Introduction

1-1 Overview

The 6U SuperBlade is a compact self-contained server that connects to a pre-cabled enclosure that provides power, cooling, management and networking functions. One enclosure can hold up to either ten or twenty blade servers, depending upon the blade enclosure. This new generation of the 6U SuperBlade enclosure is designed to deliver a much higher system density, and to incorporate many latest technologies to satisfy the increasing demands of modern technology and higher computing power.

In this manual, “blade system” refers to the entire system (including the enclosure and blades servers), “blade” or “blade server” refers to a single blade module and “blade enclosure” is the unit that the blades, power supplies and modules are housed in.

Each blade server is optimized to fit into either a specific ten-blade or twenty-blade enclosure.

Please refer to our web site for information on operating systems that have been certified for use with the 6U SuperBlade at: www.supermicro.com/products/superblade/.

1-2 Quick Start Setup

This section covers how to quickly get your new 6U SuperBlade system up and running. Follow the procedure below to quickly setup your 6U SuperBlade system.

1. Unpack the components of your 6U SuperBlade system and check the packing list for damaged or missing components.
2. Select a setup location for your system. See "[Choosing a Setup Location](#)" on [page 3-1](#) for details.
3. Mount the 6U SuperBlade chassis in your server rack. See "[Installing the System Into a Rack](#)" on [page 3-3](#) for details.
4. Install the power supply modules into the rear of the 6U SuperBlade chassis. See "[Installing a Power Supply](#)" on [page 5-4](#) for details.
5. Install the CMM module and any switch modules into the rear of the 6U SuperBlade chassis.
 - a. For the CMM module, see "[CMM Module Installation](#)" on [page 4-5](#) for details.
 - b. For the Ethernet modules, see the *6U SuperBlade Network Modules User's Manual* for details.
 - c. Attach keyboard, mouse and video connections to your CMM module.
 - d. Attach network connections for your Ethernet modules. See the *6U SuperBlade Network Modules User's Manual* for details.

6. Setup your blade modules for use by doing the following:
 - a. Open the module case lids of each blade module. Refer to the blade module user's manual for details.
 - b. Install memory into each module. Refer to the blade module user's manual for details.
 - c. Emplace the Air Shroud when you have installed your memory for each blade module. Refer to the blade module user's manual for details.
 - d. Install the hard disk drives into each module. Refer to the blade module user's manual for details.
 - e. Install your blade modules into your 6U SuperBlade chassis. Refer to the blade module user's manual for details.
7. Connect the power cords for your 6U SuperBlade system's power supply and plug them into your power source **ONLY** after you have installed and secured all system components.
8. Power up your 6U SuperBlade system. Check to be sure all components are operating right and are not showing any fault LEDs or alarms in their operation.
9. Install your selected operating system for each blade module. Refer to the blade module user's manual for details.
10. Download a BIOS update for each of your blade modules from the [Supernano website](#).

1-3 Software Mode Selection

Using the Web-based Management Utility, you can specify your 6U SuperBlade system to use a quiet mode for quieter operation and lower fan speed. See [Section 4-1: Chassis Management Module on page 4-3](#) for further details.

1-4 Product Checklist of Typical Components

- Blade Enclosure (x1): 614E (6U, 14 full height 1-socket or 2-socket blades) or 610J (6U, 10 full height 1-socket or 2-socket blades)
- Blade Unit (minimum of 2, 14 maximum); see the Supermicro website (<http://www.supermicro.com/products/superblade/>) for a complete list of blades that can be mounted in your system. Some examples are listed below:
 - Single socket Modular Design (SP) – SBI-6419P-C3N, SBI-6119P-C3N
 - Dual socket – SBI-6429P-C3N, SBI-6129P-C3N
- Power Supplies (up to 8): PWS-2K21A-BR; see the Supermicro website (<https://www.supermicro.com/products/SuperBlade/powersupply/>) for details of power supplies available
- CMM Module (x1): MBM-CMM-FIO or MBM-CMM-001; see the Supermicro website (<https://www.supermicro.com/products/SuperBlade/management/>) for details of the management modules available

Optional components include:

- Ethernet Switches: SBM-25G-100 (Marvell 25-Gpbs), MBM-XEM-001 (Broadcom 10-Gbps), MBM-XEM-002 (Intel 10-Gbps), MBM-GEM-001 (Intel 1-Gbps), MBM-GEM-004 (Broadcom 1-Gbps)

Additional modules will periodically become available. Please refer to <http://www.supermicro.com/products/superblade> for the most current list of modules available for the 6U SuperBlades.

Blade systems install into standard racks. Up to seven 6U blades systems may be installed into a 19" industry standard 42U rack.

For some details on the combinations and types of networking modules available, see [Table 1-1](#) below. See the *SuperBlade Network Modules User Manual* for full details on available modules for the SuperBlade system.

Table 1-1. Networking Module Solutions

Model	Speed	Protocol	Maximum Number	Notes
SBM-25G-100	25	Ethernet	Up to 4	25G Marvel Switch
MBM-XEM-001	10G	Ethernet	Up to 4	56x 10G/2.5G/1G Ethernet downloads, 4x 40G Ethernet uplinks, 1 console port, 1 USB port, PHY: 960G/40G optical/copper QSFP+
MBM-XEM-002	10G	Ethernet	Up to 4	56x 10G/2.5G/1G Ethernet downlinks, 2x 40G Ethernet QSFP+ or, 1x 40G and 4x 10G Ethernet uplinks, 1 console port, 1 USB port PHY: 1280G/40G optical/copper QSFP+, Optional 10G Ethernet optical/copper SFP+
MBM-GEM-001	1G	Ethernet	Up to 4	56x 2.5G/1G Ethernet downlinks, 1 Gigabit Ethernet, 2x 40G Ethernet or 8x 10G Ethernet uplinks, 1 console port, 1 USB port PHY: 442G/40G optical/copper QSFP+, 10G optical/copper SFP+, Gigabit Ethernet copper RJ45
MBM-GEM-004	1G	Ethernet	Up to 4	40x 1G Ethernet downlinks, 8x 1G Ethernet RJ45 and optional 4x 10G Ethernet Uplinks, 1 console port PHY: 176G, Optional 10G optical/copper SFP+, Gigabit Ethernet copper RJ45

1-5 Blade Enclosure Features

The 6U Supermicro's blade enclosure is designed to house up to 14 blade units. Each accommodates up to eight power supplies. The enclosure mid-plane allows the blade units to share power, cooling and networking. [Table 1-2](#) below describes the various enclosures, their components and modules. [Table 1-3](#) shows the number of each module that may be installed in the various enclosure models.

Please check the Supermicro website for the latest module and enclosure installation information at <http://www.supermicro.com/servers/blade/networking/matrix.cfm> for further details.

Table 1-2. 6U SuperBlade Enclosures

Enclosure Model	Blade Module Capacity	Power Supply Options	Blade Options	Module Options	Remarks
SBE-614E					
SBE-614E-822	14x1-socket 14x2-socket	8x2200W	SBI-6419P-C3N SBI-6420P-C3N SBI-6119R-C3N SBI-6119R-T3N	MBM-CMM-FIO (CMM Front IO Supported) MBM-CMM-001 (CMM Module) MBM-XEM-002 (Broadcom 10G Switch Module)	Support up to: One CMM Module Two 10G/1G Ethernet Switch Modules
SBE-614E-622		6x2200W plus 2xCooling Fans			
SBE-614E-422		4x2200W plus 4xCooling Fans			
SBE-614EB-422		4x2200W plus 4x1200W BBP			
SBE-610J					
SBE-610J-822	10x1-socket 10x2-socket	8x2200W	SBI-6119P-C3N SBI-6129P-C3N SBI-6119R-C3N SBI-6119R-T3N	MBM-CMM-FIO (CMM Front IO Supported) MBM-CMM-001 (CMM Module) MBM-XEM-002 (Broadcom 10G Switch Module) SBM-25G-100 (Marvell 25G Switch Module)	Support up to: Two CMM Module Four 25G/10G/1G Ethernet Switches
SBE-610J-622		6x2200W plus 2xCooling Fans			
SBE-610J-422		4x2200W plus 4xCooling Fans			
SBE-610JB-422		4x2200W plus 4x1200W BBP			

Table 1-3. Number of Network Modules that May Be Installed in each Enclosure

Name (SKU)	SBM-614E Number	SBM-610J Number
Max. CMM Modules supported	1	2
1G Ethernet Switch(MBM-GEM-001)	2	4
Broadcom 10G Switch (MBM-XEM-001)	2	4
Intel 10G Switch (MBM-XEM-002)	2	4
Broadcom 1G Switch (MBM-GEM-004)	2	4
Marvell 25G Switch (SBM-25G-100)	0	4

The following sections provide a general outline of the main features for all blade server enclosures.

Power

The typical blade enclosure features a 2200W power system composed of up to two, four, six, or eight power supply modules, depending upon model selected. An alternate configuration (and required for a full 14-blade system) features a full total of four or eight power supply modules for redundancy. This power redundancy feature allows you to replace the failing power module while the backup module takes over to keep the system running. You must have either two, four, six or eight power supply modules installed in the blade enclosure.

The Chassis Management Module assumes the worst case (maximum) power for any model of blade prior to applying power. If the power supplies cannot supply that amount of the required power for the given load on the power supplies, then the CMM will not allow that unit to power up. After a blade is powered up, the blade's BIOS calculates the actual power load required by the blade based upon the installed devices and informs the CMM of its requirements. The CMM then adjusts the remaining supply of power for additional blades based upon the actual delta of the total power, minus the amount of power being used by the blades that are powered on.

Middle Plane

The middle plane connects the various capabilities of the blades, such as the various speed switch(es) to Network Interface Controller(s), the Chassis Management Module (CMM) to the USB devices to the Host Channel Adapters. These devices all connect to the middle plane through high density connectors that provide both signals and power. This type of configuration reduces the amount of system cabling and simplifies the task of setting up the system. It provides an alternative signals route to support redundant power, CMM, network and IPMI functions.

NOTE: Signaling information can NOT be physically routed from one blade to another.

LEDs

Two LEDs are located at the right top of the enclosure above the last or right most blade. The left LED provides Power Status information and the right LED is the Fault LED.

Enclosure Cooling

The cooling for the entire blade system is provided by the fans in the power supply modules or optional fans that can be installed in place of a power supply. If a power supply fails, its fans will continue to operate to provide continuous cooling. For this reason, a failed power supply should remain installed in the enclosure until a replacement unit is ready.

NOTE: Fans are controlled by Auto Mode or User Mode (User Mode from level 1 to 10).

WARNING: The fans are very noisy at full speed and it is recommended that they not be run at full speed when in use in an office or near populated workstations.

For both enclosures, additional cooling fan modules, each with two cooling fans, can be added in place of power supplies in the rear of the enclosure.

NOTE: In order to prevent air flow leaks that would reduce cooling efficiency in the blade system's enclosure, install dummy blades to close off any blade slots that do not have active blade modules installed in them.

For overheat problems, check that there are no obstructions (such as poorly routed cables), check that all fans are operating normally and make sure the ambient room temperature is not too warm (refer to [Section A-2: Environmental Specifications on page A-2](#) for the maximum operating temperature). You can also use either of the blade management software utilities to increase the fan speed and maximize system cooling.

In the event of a power overload, you will have to add additional power supply modules to take up the load. Otherwise, you will not be able to power up all the blade modules. The blade BIOS plus CMM firmware calculates the load to determine if the power supplies can adequately handle the total system configuration.

1-6 Power Supply Features

The 6U SuperBlade enclosure comes standard with one CMM module and up to eight power supplies, depending on model selected. Information on the power supplies is summarized below. See [Section 4-1: Chassis Management Module on page 4-3](#) for details on the CMM module and [Chapter 5](#) for details on the power supplies.

If you install only half the total power supplies in the enclosure, they should be installed in the lower rather than the upper power bays. The reason for this counter-intuitive installation is that the power supplies in the lower bays provide increased airflow across the memory modules within each blade module. See the tables below for details on the power supplies for the different models of enclosures.

Table 1-4. Enclosure Models and Power Supply Combinations

Enclosure Model	Power Supplies and Fan Combinations
SBE-614E-822	Eight 2200W power supplies
SBE-614E-622	Six 2200W power supplies plus two cooling fans
SBE-614E-422	Four 2200W power supplies plus four cooling fans
SBE-614EB-422	Four 2200W power supplies plus four 1200W BBP's
SBE-610J-822	Eight 2200W power supplies
SBE-610J-622	Six 2200W power supplies plus two cooling fans
SBE-610J-422	Four 2200W power supplies plus four cooling fans
SBE-610JB-422	Four 2200W power supplies plus four 1200W BBP's

Table 1-5. Model Power Supply Populations

8 Power Supplies			
Power Supply-A1	Power Supply-A2	Power Supply-A3	Power Supply-A4
PSU	PSU	PSU	PSU
Power Supply-B1	Power Supply-B2	Power Supply-B3	Power Supply-B4
PSU	PSU	PSU	PSU
6 Power Supplies			
Power Supply-A1	Power Supply-A2	Power Supply-A3	Power Supply-A4
PSU	PSU	PSU	Dummy Fan
Power Supply-B1	Power Supply-B2	Power Supply-B3	Power Supply-B4
Dummy Fan	PSU	PSU	PSU
4 Power Supplies			
Power Supply-A1	Power Supply-A2	Power Supply-A3	Power Supply-A4
Dummy Fan	PSU	PSU	Dummy Fan
Power Supply-B1	Power Supply-B2	Power Supply-B3	Power Supply-B4
Dummy Fan	PSU	PSU	Dummy Fan
Battery Backup			
Power Supply-A1	Power Supply-A2	Power Supply-A3	Power Supply-A4
BBP	PSU	PSU	BBP
Power Supply-B1	Power Supply-B2	Power Supply-B3	Power Supply-B4
BBP	PSU	PSU	BBP

NOTE 1: Power supplies are numbered A1 through A4 for the top row, from left to right (facing the rear of the enclosure), and B1 through B4 for the bottom row.

NOTE 2: PSU = Indicates that a Power Supply Unit is installed at this location.

NOTE 3: BPP = Indicates that a Battery Backup Power supply is installed at this location.

Power Supply Modules

Each power supply module has its own power cord. Eight modules are required when the full complement of blade units are installed into an enclosure. An LED on the back of a power supply will be red when AC power is present and green when the power is on.

Supermicro's high-efficiency blade system power supplies deliver continuous redundant power up to 96% peak efficiency. Each power supply module includes a management module that monitors the power supplies and the power enclosure.

See [Chapter 5](#) for specifications and details on the power supplies available for the SuperBlade system.

Power Cord

Each power supply module has a C-14 type socket (IEC-60320-C14) for AC power and the power cord must have a C-13 type connector (IEC-60320-C13) to connect to the power supply.

A plastic locking clip partially covering the socket was designed to prevent the power supply module from being removed with the power cord still connected.

Refer to [Appendix A](#) for power/amperage calculation tables. Refer to the [supermicro web site](#) for further details on power cords.

Power Supply Failure

If a power supply or a fan in a power supply fails, the system management software will notify you of the situation. In either case, you will need to replace the power supply module with another identical one. Please note that if a power supply fails, its fans will continue to operate to provide system cooling. For this reason, a failed power supply should remain installed in the enclosure until a replacement unit is ready.

See [Chapter 5](#) for the procedure on replacing power supplies.

1-7 Special Design Features

Supermicro's 6U SuperBlade offers special design features, some of which no other blade server can duplicate. These features give you extraordinary flexibility in configuring a blade system for your own particular needs.

Operating System Support

Please check with the SMC web page for certified OS at: https://www.supermicro.com/support/resources/OS/OS_Certification_Intel.cfm.

Remote Management

The Chassis Management Module (CMM) can manage the whole enclosure and any individual blade module by switching around to it.

NOTE: Some Blade modules already have onboard BMC.

Computing Density/Power

Single and dual core processors are supported in the blade module systems. Each 6U SuperBlade mainboard supports one or two processors and up to 1.5 TB of main memory. This translates to a maximum potential of up to 28 processors and 21 TB of memory per 14-blade enclosure, or 196 processors and 147 TB of memory for a 42U rack of seven 6U enclosures.

High-Efficiency Power Supplies

A reliable source of power is critical in server systems and even more so in a blade system, where up to fourteen systems (blades) share the same power source. 6U SuperBlade power supplies have been designed to operate at up to 96% peak efficiency and provide redundancy. Using high-efficiency power supplies results in a measurable reduction in wasted energy consumption and generated heat.

1-8 Returning Merchandise for Service

A receipt or copy of your invoice marked with the date of purchase is required before any warranty service will be rendered. You can obtain service by calling your vendor for a Returned Merchandise Authorization (RMA) number. When returning to the manufacturer, the RMA number should be prominently displayed on the outside of the shipping carton, and mailed prepaid or hand-carried. Shipping and handling charges will be applied for all orders that must be mailed when service is complete.

This warranty only covers normal consumer use and does not cover damages incurred in shipping or from failure due to the alteration, misuse, abuse or improper maintenance of products.

During the warranty period, contact your distributor first for any product problems.

For faster service, RMA authorizations may be requested online at:

<http://www.supermicro.com/support/rma/>

1-9 Contacting Supermicro

Headquarters

Address: Super Micro Computer, Inc.
980 Rock Ave.
San Jose, CA 95131 U.S.A.

Tel: +1 (408) 503-8000

Fax: +1 (408) 503-8008

Email: marketing@supermicro.com (General Information)
support@supermicro.com (Technical Support)

Website: www.supermicro.com

Europe

Address: Super Micro Computer B.V.
Het Sterrenbeeld 28, 5215 ML
's-Hertogenbosch, The Netherlands

Tel: +31 (0) 73-6400390

Fax: +31 (0) 73-6416525

Email: sales@supermicro.nl (General Information)
support@supermicro.nl (Technical Support)
rma@supermicro.nl (Customer Support)

Asia-Pacific

Address: Super Micro Computer, Inc.
3F, No. 150, Jian 1st Rd.
Zhonghe Dist., New Taipei City 23511
Taiwan (R.O.C)

Tel: +886-(2) 8226-3990

Fax: +886-(2) 8226-3992

Website: www.supermicro.com.tw

Technical Support:

Email: support@supermicro.com.tw

Chapter 2

Standardized Warning Statements

2-1 About Standardized Warning Statements

The following statements are industry standard warnings, provided to warn the user of situations which have the potential for bodily injury. Should you have questions or experience difficulty, contact Supermicro's Technical Support department for assistance. Only certified technicians should attempt to install or configure components.

Read this appendix in its entirety before installing or configuring components in the Supermicro chassis

These warnings may also be found on our web site at http://www.supermicro.com/about/policies/safety_information.cfm.

Warning Definition



Warning!

This warning symbol means danger. You are in a situation that could cause bodily injury. Before you work on any equipment, be aware of the hazards involved with electrical circuitry and be familiar with standard practices for preventing accidents.

警告の定義

この警告サインは危険を意味します。

人身事故につながる可能性がありますので、いずれの機器でも動作させる前に、電気回路に含まれる危険性に注意して、標準的な事故防止策に精通して下さい。

此警告符号代表危險。

您正處於可能受到嚴重傷害的工作環境中。在您使用設備開始工作之前，必須充分意識到觸電的危險，並熟練掌握防止事故發生的標準工作程序。請根據每項警告結尾的聲明號碼找到此設備的安全性警告說明的翻譯文本。

此警告符號代表危險。

您正處於可能身體可能會受損傷的工作環境中。在您使用任何設備之前，請注意觸電的危險，並且要熟悉預防事故發生的標準工作程序。請依照每一注意事項後的號碼找到相關的翻譯說明內容。

Warnung

WICHTIGE SICHERHEITSHINWEISE

Dieses Warnsymbol bedeutet Gefahr. Sie befinden sich in einer Situation, die zu Verletzungen führen kann. Machen Sie sich vor der Arbeit mit Geräten mit den Gefahren elektrischer Schaltungen und den üblichen Verfahren zur Vorbeugung vor Unfällen vertraut. Suchen Sie mit der am Ende jeder Warnung angegebenen Anweisungsnummer nach der jeweiligen Übersetzung in den übersetzten Sicherheitshinweisen, die zusammen mit diesem Gerät ausgeliefert wurden.

BEWAHREN SIE DIESE HINWEISE GUT AUF.

INSTRUCCIONES IMPORTANTES DE SEGURIDAD

Este símbolo de aviso indica peligro. Existe riesgo para su integridad física. Antes de manipular cualquier equipo, considere los riesgos de la corriente eléctrica y familiarícese con los procedimientos estándar de prevención de accidentes. Al final de cada advertencia encontrará el número que le ayudará a encontrar el texto traducido en el apartado de traducciones que acompaña a este dispositivo.

GUARDE ESTAS INSTRUCCIONES.

IMPORTANTES INFORMATIONS DE SÉCURITÉ

Ce symbole d'avertissement indique un danger. Vous vous trouvez dans une situation pouvant entraîner des blessures ou des dommages corporels. Avant de travailler sur un équipement, soyez conscient des dangers liés aux circuits électriques et familiarisez-vous avec les procédures couramment utilisées pour éviter les accidents. Pour prendre connaissance des traductions des avertissements figurant dans les consignes de sécurité traduites qui accompagnent cet appareil, référez-vous au numéro de l'instruction situé à la fin de chaque avertissement.

CONSERVEZ CES INFORMATIONS.

תקנתן הצהרות אזהרה

הצהרות הבאות הן אזהרות על פי תקני התעשייה, על מנת להזהיר את המשתמש מפני חבלה פיזית אפשרית. במידה ויש שאלות או היתקלות בבעיה כלשהי, יש ליצור קשר עם מחלקת תמיכה טכנית של סופרמיקרו. טכנאים מוסמכים בלבד רשאים להתקין או להגדיר את הרכיבים.

יש לקרוא את הנספח במלואו לפני התקנת או הגדרת הרכיבים במארזי סופרמיקרו.

تحذير! هذا الرمز يعني خطر انك في حالة يمكن أن تتسبب في إصابة جسدية .
قبل أن تعمل على أي معدات، كن على علم بالمخاطر الناجمة عن الدوائر
الكهربائية

وكن على دراية بالممارسات الوقائية لمنع وقوع أي حوادث
استخدم رقم البيان المنصوص في نهاية كل تحذير للعثور ترجمتها

안전을 위한 주의사항

경고!

이 경고 기호는 위험이 있음을 알려 줍니다. 작업자의 신체에 부상을 야기 할 수 있는 상태에 있게 됩니다. 모든 장비에 대한 작업을 수행하기 전에 전기회로와 관련된 위험 요소들을 확인하시고 사전에 사고를 방지할 수 있도록 표준 작업절차를 준수해 주시기 바랍니다.

해당 번역문을 찾기 위해 각 경고의 마지막 부분에 제공된 경고문 번호를 참조하십시오

BELANGRIJKE VEILIGHEIDSINSTRUCTIES

Dit waarschuwings symbool betekent gevaar. U verkeert in een situatie die lichamelijk letsel kan veroorzaken. Voordat u aan enige apparatuur gaat werken, dient u zich bewust te zijn van de bij een elektrische installatie betrokken risico's en dient u op de hoogte te zijn van de standaard procedures om ongelukken te voorkomen. Gebruik de nummers aan het eind van elke waarschuwing om deze te herleiden naar de desbetreffende locatie.

BEWAAR DEZE INSTRUCTIES

Installation Instructions



Warning!

Read the installation instructions before connecting the system to the power source.

設置手順書

システムを電源に接続する前に、設置手順書をお読み下さい。

警告

将此系统连接电源前，请先阅读安装说明。

警告

將系統與電源連接前，請先閱讀安裝說明。

Warnung

Vor dem Anschließen des Systems an die Stromquelle die Installationsanweisungen lesen.

¡Advertencia!

Lea las instrucciones de instalación antes de conectar el sistema a la red de alimentación.

Attention

Avant de brancher le système sur la source d'alimentation, consulter les directives d'installation.

יש לקרוא את הוראות התקנה לפני חיבור המערכת למקור מתח.

اقر إرشادات التركيب قبل توصيل النظام إلى مصدر للطاقة
시스템을 전원에 연결하기 전에 설치 안내를 읽어주십시오.

Waarschuwing

Raadpleeg de installatie-instructies voordat u het systeem op de voedingsbron aansluit.

Circuit Breaker



Warning!

This product relies on the building's installation for short-circuit (overcurrent) protection. Ensure that the protective device is rated not greater than: 250 V, 20 A.

サーキット・ブレーカー

この製品は、短絡（過電流）保護装置がある建物での設置を前提としています。

保護装置の定格が 250 V、20 A を超えないことを確認下さい。

警告

此产品的短路（过载电流）保护由建筑物的供电系统提供，确保短路保护设备的额定电流不大于 250V, 20A。

警告

此產品的短路（過載電流）保護由建築物的供電系統提供，確保短路保護設備的額定電流不大於 250V, 20A。

Warnung

Dieses Produkt ist darauf angewiesen, dass im Gebäude ein Kurzschluss- bzw. Überstromschutz installiert ist. Stellen Sie sicher, dass der Nennwert der Schutzvorrichtung nicht mehr als: 250 V, 20 A beträgt.

¡Advertencia!

Este equipo utiliza el sistema de protección contra cortocircuitos (o sobrecorrientes) del edificio. Asegúrese de que el dispositivo de protección no sea superior a: 250 V, 20 A.

Attention

Pour ce qui est de la protection contre les courts-circuits (surtension), ce produit dépend de l'installation électrique du local. Vérifiez que le courant nominal du dispositif de protection n'est pas supérieur à :250 V, 20 A.

מוצר זה מסתמך על הגנה המותקנת במבנים למניעת קצר חשמלי. יש לוודא כי
המכשיר המגן מפני הקצר החשמלי הוא לא יותר מ-250 V, 20 A

هذا المنتج يعتمد على معدات الحماية من الدوائر القصيرة التي تم تثبيتها في
المبنى
تأكد من أن تقييم الجهاز الوقائي ليس أكثر من: 20A, 250V

경고 !

이 제품은 전원의 단락 (과전류) 방지에 대해서 전적으로 건물의 관련 설비에 의존합니다. 보호장치의 정격이 반드시 250V(볼트), 20A(암페어)를 초과하지 않도록 해야 합니다.

Waarschuwing

Dit product is afhankelijk van de kortsluitbeveiliging (overspanning) van uw elektrische installatie. Controleer of het beveiligde apparaat niet groter gedimensioneerd is dan 220V, 20A.

Power Disconnection Warning



Warning!

The system must be disconnected from all sources of power and the power cord removed from the power supply module(s) before accessing the chassis interior to install or remove system components.

電源切斷の警告

システムコンポーネントの取り付けまたは取り外しのために、シャーシ内部にアクセスするには、

システムの電源はすべてのソースから切斷され、電源コードは電源モジュールから取り外す必要があります。

警告

在你打开机箱并安装或移除内部器件前，必須將系統完全斷電，并移除電源線。

警告

在您打開機殼安裝或移除內部元件前，必須將系統完全斷電，並移除電源線。

Warnung

Das System muss von allen Quellen der Energie und vom Netzanschlusskabel getrennt sein, das von den Spg.Versorgungsteilmodulen entfernt wird, bevor es auf den Chassisinnenraum zurückgreift, um Systemsbestandteile anzubringen oder zu entfernen.

¡Advertencia!

El sistema debe ser disconnected de todas las fuentes de energía y del cable eléctrico quitado de los módulos de fuente de alimentación antes de tener acceso el interior del chasis para instalar o para quitar componentes de sistema.

Attention

Le système doit être débranché de toutes les sources de puissance ainsi que de son cordon d'alimentation secteur avant d'accéder à l'intérieur du châssis pour installer ou enlever des composants de système.

אזהרה מפני ניתוק חשמלי

!אזהרה

יש לנתק את המערכת מכל מקורות החשמל ויש להסיר את כבל החשמלי מהספק לפני גישה לחלק הפנימי של המארז לצורך התקנת או הסרת רכיבים.

يجب فصل النظام من جميع مصادر الطاقة وإزالة سلك الكهرباء من وحدة امداد الطاقة قبل

الوصول إلى المناطق الداخلية للهيكل لتثبيت أو إزالة مكونات الجهاز

경고 !

시스템에 부품들을 장착하거나 제거하기 위해서는 채시 내부에 접근하기 전에 반드시 전원 공급장치로부터 연결되어있는 모든 전원과 전기코드를 분리해주어야 합니다.

Waarschuwing

Voordat u toegang neemt tot het binnenwerk van de behuizing voor het installeren of verwijderen van systeem onderdelen, dient u alle spanningsbronnen en alle stroomkabels aangesloten op de voeding(en) van de behuizing te verwijderen.

Equipment Installation



Warning!

Only trained and qualified personnel should be allowed to install, replace, or service this equipment.

機器の設置

トレーニングを受け認定された人だけがこの装置の設置、交換、またはサービスを許可されています。

警告

只有经过培训且具有资格的人员才能进行此设备的安装、更换和维修。

警告

只有經過受訓且具資格人員才可安裝、更換與維修此設備。

Warnung

Das Installieren, Ersetzen oder Bedienen dieser Ausrüstung sollte nur geschultem, qualifiziertem Personal gestattet werden.

¡Advertencia!

Solamente el personal calificado debe instalar, reemplazar o utilizar este equipo.

Attention

Il est vivement recommandé de confier l'installation, le remplacement et la maintenance de ces équipements à des personnels qualifiés et expérimentés.

!אזהרה

צוות מוסמך בלבד רשאי להתקין, להחליף את הציוד או לתת שירות עבור הציוד.

يجب أن يسمح فقط للموظفين المؤهلين والمدربين لتكيب واستبدال أو خدمة هذا الجهاز
경고!

훈련을 받고 공인된 기술자만이 이 장비의 설치, 교체 또는 서비스를 수행할 수 있습니다.

Waarschuwing

Deze apparatuur mag alleen worden geïnstalleerd, vervangen of hersteld door geschoold en gekwalificeerd personeel.

Restricted Area



Warning!

This unit is intended for installation in restricted access areas. A restricted access area can be accessed only through the use of a special tool, lock and key, or other means of security. (This warning does not apply to workstations).

アクセス制限区域

このユニットは、アクセス制限区域に設置されることを想定しています。

アクセス制限区域は、特別なツール、鍵と錠前、その他のセキュリティの手段を用いてのみ出入りが可能です。

警告

此部件应安装在限制进出的场所，限制进出的场所指只能通过使用特殊工具、锁和钥匙或其它安全手段进出的场所。

警告

此裝置僅限安裝於進出管制區域，進出管制區域係指僅能以特殊工具、鎖頭及鑰匙或其他安全方式才能進入的區域。

Warnung

Diese Einheit ist zur Installation in Bereichen mit beschränktem Zutritt vorgesehen. Der Zutritt zu derartigen Bereichen ist nur mit einem Spezialwerkzeug, Schloss und Schlüssel oder einer sonstigen Sicherheitsvorkehrung möglich.

¡Advertencia!

Esta unidad ha sido diseñada para instalación en áreas de acceso restringido. Sólo puede obtenerse acceso a una de estas áreas mediante la utilización de una herramienta especial, cerradura con llave u otro medio de seguridad.

Attention

Cet appareil doit être installée dans des zones d'accès réservés. L'accès à une zone d'accès réservé n'est possible qu'en utilisant un outil spécial, un mécanisme de verrouillage et une clé, ou tout autre moyen de sécurité.

אזור עם גישה מוגבלת

אזהרה!

יש להתקין את היחידה באזורים שיש בהם הגבלת גישה. הגישה ניתנת בעזרת כלי אבטחה בלבד (מפתח, מנעול וכד').

تم تخصيص هذه الوحدة لتركيبها في مناطق محظورة .
يمكن الوصول إلى منطقة محظورة فقط من خلال استخدام أداة خاصة،
قفل ومفتاح أو أي وسيلة أخرى للأمان

경고!

이 장치는 접근이 제한된 구역에 설치하도록 되어있습니다. 특수도구, 잠금 장치 및 키, 또는 기타 보안 수단을 통해서만 접근 제한 구역에 들어갈 수 있습니다.

Waarschuwing

Dit apparaat is bedoeld voor installatie in gebieden met een beperkte toegang. Toegang tot dergelijke gebieden kunnen alleen verkregen worden door gebruik te maken van speciaal gereedschap, slot en sleutel of andere veiligheidsmaatregelen.

Battery Handling



Warning!

There is the danger of explosion if the battery is replaced incorrectly. Replace the battery only with the same or equivalent type recommended by the manufacturer. Dispose of used batteries according to the manufacturer's instructions.

電池の取り扱い

電池交換が正しく行われなかった場合、破裂の危険性があります。交換する電池はメーカーが推奨する型、または同等のものを使用下さい。使用済電池は製造元の指示に従って処分して下さい。

警告

電池更換不當會有爆炸危險。請只使用同類電池或製造商推薦的功能相當的電池更換原有電池。請按製造商的說明處理廢舊電池。

警告

電池更換不當會有爆炸危險。請使用製造商建議之相同或功能相當的電池更換原有電池。請按照製造商的說明指示處理廢棄舊電池。

Warnung

Bei Einsetzen einer falschen Batterie besteht Explosionsgefahr. Ersetzen Sie die Batterie nur durch den gleichen oder vom Hersteller empfohlenen Batterietyp. Entsorgen Sie die benutzten Batterien nach den Anweisungen des Herstellers.

Attention

Danger d'explosion si la pile n'est pas remplacée correctement. Ne la remplacer que par une pile de type semblable ou équivalent, recommandée par le fabricant. Jeter les piles usagées conformément aux instructions du fabricant.

¡Advertencia!

Existe peligro de explosión si la batería se reemplaza de manera incorrecta. Reemplazar la batería exclusivamente con el mismo tipo o el equivalente recomendado por el fabricante. Desechar las baterías gastadas según las instrucciones del fabricante.

אזהרה!

קיימת סכנת פיצוץ של הסוללה במידה והוחלפה בדרך לא תקינה. יש להחליף את הסוללה בסוג התואם מחברת יצרן מומלצת.

סילוק הסוללות המשומשות יש לבצע לפי הוראות היצרן.

هناك خطر من انفجار في حالة استبدال البطارية بطريقة غير صحيحة فعليك استبدال البطارية

فقط بنفس النوع أو ما يعادلها كما أوصت به الشركة المصنعة تخلص من البطاريات المستعملة وفقا لتعليمات الشركة الصانعة

경고!

배터리가 올바르게 교체되지 않으면 폭발의 위험이 있습니다. 기존 배터리와 동일하거나 제조사에서 권장하는 동등한 종류의 배터리로만 교체해야 합니다. 제조사의 안내에 따라 사용된 배터리를 처리하여 주십시오.

Waarschuwing

Er is ontploffingsgevaar indien de batterij verkeerd vervangen wordt. Vervang de batterij slechts met hetzelfde of een equivalent type die door de fabrikant aanbevolen wordt. Gebruikte batterijen dienen overeenkomstig fabrieksvoorschriften afgevoerd te worden.

Redundant Power Supplies



Warning!

This unit might have more than one power supply connection. All connections must be removed to de-energize the unit.

冗長電源装置

このユニットは複数の電源装置が接続されている場合があります。

ユニットの電源を切るためには、すべての接続を取り外さなければなりません。

警告

此部件连接的电源可能不止一个，必须将所有电源断开才能停止给该部件供电。

警告

此裝置連接的電源可能不只一個，必須切斷所有電源才能停止對該裝置的供電。

Warnung

Dieses Gerät kann mehr als eine Stromzufuhr haben. Um sicherzustellen, dass der Einheit kein Strom zugeführt wird, müssen alle Verbindungen entfernt werden.

¡Advertencia!

Puede que esta unidad tenga más de una conexión para fuentes de alimentación. Para cortar por completo el suministro de energía, deben desconectarse todas las conexiones.

Attention

Cette unité peut avoir plus d'une connexion d'alimentation. Pour supprimer toute tension et tout courant électrique de l'unité, toutes les connexions d'alimentation doivent être débranchées.

אם קיים יותר מספק אחד

אזהרה!

ליחידה יש יותר מחיבור אחד של ספק. יש להסיר את כל החיבורים על מנת לרוקן את היחידה.

قد يكون لهذا الجهاز عدة اتصالات بوحدات امداد الطاقة.
يجب إزالة كافة الاتصالات لعزل الوحدة عن الكهرباء

경고 !

이 장치에는 한 개 이상의 전원 공급 단자가 연결되어 있을 수 있습니다. 이 장치에 전원을 차단하기 위해서는 모든 연결 단자를 제거해야만 합니다.

Waarschuwing

Deze eenheid kan meer dan één stroomtoevoeraansluiting bevatten. Alle aansluitingen dienen verwijderd te worden om het apparaat stroomloos te maken

Backplane Voltage



Warning!

Hazardous voltage or energy is present on the backplane when the system is operating. Use caution when servicing.

バックプレーンの電圧

システムの稼働中は危険な電圧または電力が、バックプレーン上にかかっています。

修理する際にはご注意ください。

警告

当系统正在进行时，背板上有很危险的电压或能量，进行维修时务必小心。

警告

當系統正在進行時，背板上有危險的電壓或能量，進行維修時務必小心。

Warnung

Wenn das System in Betrieb ist, treten auf der Rückwandplatine gefährliche Spannungen oder Energien auf. Vorsicht bei der Wartung.

¡Advertencia!

Quando el sistema está en funcionamiento, el voltaje del plano trasero es peligroso. Tenga cuidado cuando lo revise.

Attention

Lorsque le système est en fonctionnement, des tensions électriques circulent sur le fond de panier. Prendre des précautions lors de la maintenance.

מתח בפנל האחורי

אזהרה !

קיימת סכנת מתח בפנל האחורי בזמן תפעול המערכת. יש להיזהר במהלך העבודה.

هناك خطر من التيار الكهربائي أو الطاقة الموجودة على اللوحة
عندما يكون النظام يعمل كن حذرا عند خدمة هذا الجهاز

경고 !

시스템이 동작 중일 때 후면판 (Backplane) 에는 위험한 전압이나 에너지가 발생 합니다. 서비스 작업 시 주의하십시오 .

Waarschuwing

Een gevaarlijke spanning of energie is aanwezig op de backplane wanneer het systeem in gebruik is. Voorzichtigheid is geboden tijdens het onderhoud.

Comply with Local and National Electrical Codes



Warning!

Installation of the equipment must comply with local and national electrical codes.

地方および国の電気規格に準拠

機器の取り付けはその地方および国の電気規格に準拠する必要があります。

警告

设备安装必须符合本地与本国电气法规。

警告

設備安裝必須符合本地與本國電氣法規。

Warnung

Die Installation der Geräte muss den Sicherheitsstandards entsprechen.

¡Advertencia!

La instalacion del equipo debe cumplir con las normas de electricidad locales y nacionales.

Attention

L'équipement doit être installé conformément aux normes électriques nationales et locales.

תיאום חוקי החשמל הארצי

אזהרה !

התקנת הציוד חייבת להיות תואמת לחוקי החשמל המקומיים והארציים.

تركيب المعدات الكهربائية يجب أن يمتثل للقوانين المحلية والوطنية المتعلقة
بالكهرباء

경고!

현 지역 및 국가의 전기 규정에 따라 장비를 설치해야 합니다.

Waarschuwing

Bij installatie van de apparatuur moet worden voldaan aan de lokale en nationale elektriciteitsvoorschriften.

Product Disposal



Warning!

Ultimate disposal of this product should be handled according to all national laws and regulations.

製品の廃棄

この製品を廃棄処分する場合、国の関係する全ての法律・条例に従い処理する必要があります。

警告

本产品的废弃处理应根据所有国家的法律和规章进行。

警告

本產品的廢棄處理應根據所有國家的法律和規章進行。

Warnung

Die Entsorgung dieses Produkts sollte gemäß allen Bestimmungen und Gesetzen des Landes erfolgen.

¡Advertencia!

Al deshacerse por completo de este producto debe seguir todas las leyes y reglamentos nacionales.

Attention

La mise au rebut ou le recyclage de ce produit sont généralement soumis à des lois et/ou directives de respect de l'environnement. Renseignez-vous auprès de l'organisme compétent.

סילוק המוצר

אזהרה!

סילוק סופי של מוצר זה חייב להיות בהתאם להנחיות וחוקי המדינה.

عند التخلص النهائي من هذا المنتج ينبغي التعامل معه وفقا لجميع القوانين واللوائح الوطنية

경고!

이 제품은 해당 국가의 관련 법규 및 규정에 따라 폐기되어야 합니다.

Waarschuwing

De uiteindelijke verwijdering van dit product dient te geschieden in overeenstemming met alle nationale wetten en reglementen.

Hot Swap Fan Warning



Warning!

The fans might still be turning when you remove the fan assembly from the chassis. Keep fingers, screwdrivers, and other objects away from the openings in the fan assembly's housing.

ファン・ホットスワップの警告

シャーシから冷却ファン装置を取り外した際、ファンがまだ回転している可能性があります。ファンの開口部に、指、ドライバー、およびその他のものを近づけないで下さい。

警告

当您从机架移除风扇装置，风扇可能仍在转动。小心不要将手指、螺丝起子和其他物品太靠近风扇。

警告

當您從機架移除風扇裝置，風扇可能仍在轉動。小心不要將手指、螺絲起子和其他物品太靠近風扇。

Warnung

Die Lüfter drehen sich u. U. noch, wenn die Lüfterbaugruppe aus dem Chassis genommen wird. Halten Sie Finger, Schraubendreher und andere Gegenstände von den Öffnungen des Lüftergehäuses entfernt.

¡Advertencia!

Los ventiladores podran dar vuelta cuando usted quite ell montaje del ventilador del chasis. Mandtenga los dedos, los destornilladores y todos los objetos lejos de las aberturas del ventilador

Attention

Il est possible que les ventilateurs soient toujours en rotation lorsque vous retirerez le bloc ventilateur du châssis. Prenez garde à ce que doigts, tournevis et autres objets soient éloignés du logement du bloc ventilateur.

! אזהרה

כאשר מסירים את חלקי המאוורר מהמארו, יתכן והמאווררים עדיין עובדים. יש להרחיק למרחק בטוח את האצבעות וכלי עבודה שונים מהפתחים בתוך המאוורר

من الممكن أن المراوح لا تزال تدور عند إزالة كتلة المروحة من الهيكل يجب إبقاء الأصابع ومفكات البراغي وغيرها من الأشياء بعيدا عن الفتحات في كتلة المروحة.

경고 !

새시로부터 팬 조립품을 제거할 때 팬은 여전히 회전하고 있을 수 있습니다. 팬 조립품 외관의 열려있는 부분들로부터 손가락 및 스크류드라이버, 다른 물체들이 가까이 하지 않도록 배치해 주십시오.

Waarschuwing

Het is mogelijk dat de ventilator nog draait tijdens het verwijderen van het ventilatorsamenstel uit het chassis. Houd uw vingers, schroevendraaiers en eventuele andere voorwerpen uit de buurt van de openingen in de ventilatorbehuizing.

Power Cable and AC Adapter



Warning!

When installing the product, use the provided or designated connection cables, power cables and AC adaptors. Using any other cables and adaptors could cause a malfunction or a fire. Electrical Appliance and Material Safety Law prohibits the use of UL or CSA-certified cables (that have UL/CSA shown on the code) for any other electrical devices than products designated by Supermicro only.

電源コードと AC アダプター

製品を設置する場合、提供または指定された接続ケーブル、電源コードと AC アダプターを使用下さい。他のケーブルやアダプタを使用すると故障や火災の原因になることがあります。電気用品安全法は、UL または CSA 認定のケーブル (UL/CSE マークがコードに表記) を Supermicro が指定する製品以外に使用することを禁止しています。

警告

安装此产品时,请使用本身提供的或指定的连接线,电源线和电源适配器.使用其它线材或适配器可能会引起故障或火灾。除了 Supermicro 所指定的产品,电气用品和材料安全法律规定禁止使用未经 UL 或 CSA 认证的线材。(线材上会显示 UL/CSA 符号)。

警告

安裝此產品時,請使用本身提供的或指定的連接線,電源線和電源適配器.使用其它線材或適配器可能會引起故障或火災。除了 Supermicro 所指定的產品,電氣用品和材料安全法律規定禁止使用未經 UL 或 CSA 認證的線材。(線材上會顯示 UL/CSA 符號)。

Warnung

Bei der Installation des Produkts, die zur Verfügung gestellten oder benannt Anschlusskabel, Stromkabel und Netzteile. Verwendung anderer Kabel und Adapter kann zu einer Fehlfunktion oder ein Brand entstehen. Elektrische Geräte und Material Safety Law verbietet die Verwendung von UL-oder CSA-zertifizierte Kabel, UL oder CSA auf der Code für alle anderen elektrischen Geräte als Produkte von Supermicro nur bezeichnet gezeigt haben.

¡Advertencia!

Al instalar el producto, utilice los cables de conexión previstos o designados, los cables y adaptadores de CA. La utilización de otros cables y adaptadores podría ocasionar un mal funcionamiento o un incendio. Aparatos Eléctricos y la Ley de Seguridad del Material prohíbe el uso de UL o CSA cables certificados que tienen UL o CSA se muestra en el código de otros dispositivos eléctricos que los productos designados por Supermicro solamente.

Attention

Lors de l'installation du produit, utilisez les bables de connection fournis ou désigné. L'utilisation d'autres cables et adaptateurs peut provoquer un dysfonctionnement ou un incendie. Appareils électroménagers et de loi sur la sécurité Matériel interdit l'utilisation de UL ou CSA câbles certifiés qui ont UL ou CSA indiqué sur le code pour tous les autres appareils électriques que les produits désignés par Supermicro seulement.

חשמליים ומתאמי AC

אזהרה!

כאשר מתקינים את המוצר, יש להשתמש בכבלים, ספקים ומתאמים AC אשר נועדו וסופקו לשם כך. שימוש בכל כבל או מתאם אחר יכול לגרום לתקלה או קצר חשמלי. על פי חוקי שימוש במכשירי חשמל וחוקי בטיחות, קיים איסור להשתמש בכבלים המוסמכים ב- UL או ב- CSA (כשאר מופיע עליהם קוד של UL/CSA) עבור כל מוצר חשמלי אחר שלא צוין על ידי סופרקמיקרו בלבד.

عند تركيب الجهاز يجب استخدام كابلات التوصيل، والكابلات الكهربائية

ومحولات التيار المتردد

التي . أن استخدام أي كابلات ومحولات أخرى يتسبب في حدوث عطل أو حريق.

تم توفيرها لك مع المنتج

الأجهزة الكهربائية ومواد قانون السلامة يحظر استخدام الكابلات UL أو CSA

معتمدة من قبل

لأي أجهزة كهربائية أخرى غير المنتجات المعينة من قبل Supermicro

(التي تحمل علامة UL/CSA)

경고!

제품을 설치할 때에는 제공되거나 지정된 연결케이블과 전원케이블, AC 어댑터를 사용해야 합니다. 그 밖의 다른 케이블들이나 어댑터들은 고장 또는 화재의 원인이 될 수 있습니다. 전기용품안전법 (Electrical Appliance and Material Safety Law) 은 슈퍼마이크로에서 지정한 제품들 외에는 그 밖의 다른 전기 장치들을 위한 UL 또는 CSA 에서 인증한 케이블 (전선 위에 UL/CSA 가 표시) 들의 사용을 금지합니다.

Waarschuwing

Bij het installeren van het product, gebruik de meegeleverde of aangewezen kabels, stroomkabels en adapters. Het gebruik van andere kabels en adapters kan leiden tot een storing of een brand. Elektrisch apparaat en veiligheidsinformatiebladen wet verbiedt het gebruik van UL of CSA gecertificeerde kabels die UL of CSA die op de code voor andere elektrische apparaten dan de producten die door Supermicro alleen.

Chapter 3

Setup and Installation

3-1 Overview

This chapter provides a quick setup procedure for your 6U SuperBlade. Following these steps in the order given should enable you to have the system operational within a minimum amount of time. This quick setup assumes that the processor(s) and memory have already been installed. If not, please turn to [Chapter 4](#) for details on installing specific components.

3-2 Unpacking the System

You should inspect the box the 6U SuperBlade was shipped in and note if it was damaged in any way. If the server itself shows damage you should file a damage claim with the carrier who delivered it.

Decide on a suitable location for the rack unit that will hold the 6U SuperBlade. It should be situated in a clean, dust-free area that is well ventilated. Avoid areas where heat, electrical noise and electromagnetic fields are generated. You will also need it placed near a grounded power outlet. Read the "[Rack Precautions](#)" and "[Server Precautions](#)" in the next section.

The box the 6U SuperBlade was shipped in should include two sets of rail assemblies, two handles and the mounting screws you will need to install the system into the rack. Follow the steps in the order given to complete the installation process in a minimum amount of time. **Please read this section in its entirety before you begin the installation procedure outlined in the sections that follow.**

Choosing a Setup Location

The following are important considerations for choosing a setup location:

- Leave enough clearance in front of the rack to enable you to remove the blade units (~25 inches).
- Leave approximately **30 inches of clearance behind or to the rear of the rack** to allow for sufficient airflow and ease in servicing, as well as clearance for electrical power connections.
- This product is intended for installation only in a *Restricted Access Location* (dedicated equipment rooms, service closets and the like). This is because the 6U SuperBlade enclosure does not provide any physical security measures.
- This product is not suitable for use with visual display work place devices according to §2 of the *German Ordinance for Work with Visual Display Units*.

WARNING: Please read the following important Warnings and Precautions!

Rack Precautions

The following are important precautions concerning rack setup:

- The enclosure unit is heavy and requires at least two people to lift it.
- Ensure that the leveling jacks on the bottom of the rack are fully extended to the floor with the full weight of the rack resting on them.
- In single rack installation, stabilizers should be attached to the rack.
- In multiple rack installations the racks frames should be grounded to the same earth ground as the electrical source for the power supplies by means of a grounding strap.

Server Precautions

The following are important precautions concerning server setup:

- Review the electrical and general safety precautions in [Chapter 2](#).
- Determine the placement of each component in the rack *before* you install the rails.
- Install the heaviest server components on the bottom of the rack first, and then work up.
- Use a regulating uninterruptible power supply (UPS) to protect the server from power surges, voltage spikes and to keep your system operating in case of a power failure.
- Allow the hot plug hard drives and power supply units to cool before touching them.
- Always keep the rack's front door and all panels and components on the servers closed when not servicing to maintain proper cooling.

Rack Mounting Considerations

Below are listed important considerations for rack mounting.

Ambient Operating Temperature

If installed in a closed or multi-unit rack assembly, the ambient operating temperature of the rack environment may be greater than the ambient temperature of the room. Therefore, consideration should be given to installing the equipment in an environment compatible with the manufacturer's maximum rated ambient temperature. Refer to Appendix E for operating temperature specifications.

Reduced Airflow

Equipment should be mounted into a rack so that the amount of airflow required for safe operation is not compromised.

Mechanical Loading

Equipment should be mounted into a rack so that a hazardous condition does not arise due to uneven mechanical loading.

Circuit Overloading

Consideration should be given to the connection of the equipment to the power supply circuitry and the effect that any possible overloading of circuits might have on over-current protection and power supply wiring. Appropriate consideration of equipment nameplate ratings should be used when addressing this concern. See the power calculation tables in [Appendix A](#).

Reliable Ground

A reliable ground must be maintained at all times. To ensure this, the rack itself should be grounded. Particular attention should be given to power supply connections other than the direct connections to the branch circuit (such as the use of power strips and so on).

NOTE: It is recommended that you seek the advice and assistance of a licensed electrician that can advise you on best practices for ensuring that the electrical supply and the rack are joined to a *Common Bonding Network*.

Professional documents on grounding techniques include:

- *ANSI/TIA-942 – Telecommunications Infrastructure Standard for Data Centers*
- *J-STD-607-A-2002 – Commercial Building Grounding (Earthing) and Bonding Requirements for Telecommunications*
- *IEEE Std 1100™-2005 (IEEE Emerald Book) – IEEE Recommended Practice for Powering and Grounding Electronic Equipment*

Installing the System Into a Rack

This section provides information on installing the 6U SuperBlade into a rack. There are a variety of rack units on the market, meaning the procedure may differ slightly. Refer to the Enclosure Template that was included with the system for help.

Rack Mounting Hardware

The following is a list of rack mounting hardware you will need for rack setup and installation:

- Two rail assemblies (one for each side of the enclosure)
- Two handles
- Four roundhead screws for fastening the enclosure ears to the rack
- Eight flathead screws and washers for mounting the rails to the rack

Installation

Use the procedure below for installing an enclosure in a rack.

Installing an enclosure:

1. Decide where you want to place the blade enclosure into the rack (see ["Rack Mounting Considerations"](#) in the previous section).
2. Position the Enclosure Template at the front of the enclosure to determine the locations of the screws for the enclosure rails (see [Figure 3-1](#)).

Figure 3-1. Positioning the Enclosure Template

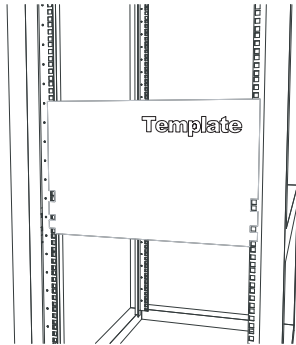

3. The two enclosure rail sections are screwed together to keep them immobile during shipping. Release these screws just enough to allow the rails to slide apart. Note the arrow on the rail, which indicates the end that attaches to the front of the rack.
4. Slide the rails apart far enough to match the depth of the rack. Position the rails with the template and secure the front of each to the front of the rack with two flathead screws, then secure the back of each rail to the rear of the rack with two flathead screws (see [Figure 3-2](#)). Note that the rails are left/right specific and very heavy.

Figure 3-2. Securing the Rails to the Rack

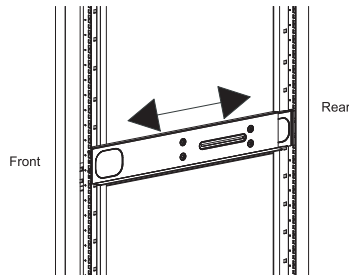

5. (Optional step) Add the front left and right handles to the enclosure using five screws to secure each handle. Install a thumbscrew through the bottom hole of each handle (see [Figure 3-3](#)).

NOTE: These handles are optional and need only be installed when mounting the system into a short rack. When mounting into a deep rack, they are unnecessary and regular screws should be used instead of thumbscrews.

Be aware that these handles are not to be used for lifting the system, they are only to be used to slide the system within the rack.

6. With one person on either side (see the descriptive label on the side of the enclosure), lift the enclosure and slide it into the installed rails.

WARNING: Be sure that the enclosure is empty of all blades, power supplies, switches and management modules **BEFORE** lifting. These should be installed **AFTER** the enclosure is mounted in the rack. Injury and damage may occur if components are not removed from the rack prior to installation.

7. After pushing the enclosure all the way into the rack, use two roundhead screws on each side of the server to lock it into place.

Figure 3-3. Attaching the Optional Handles

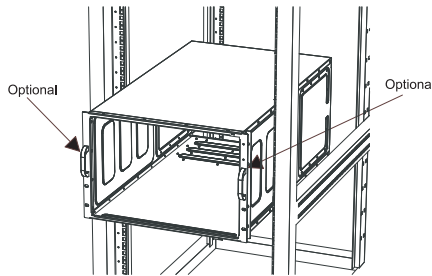

8. The enclosure is now securely installed in the rack (see [Figure 3-4](#)).

Figure 3-4. Enclosure Installed into Rack

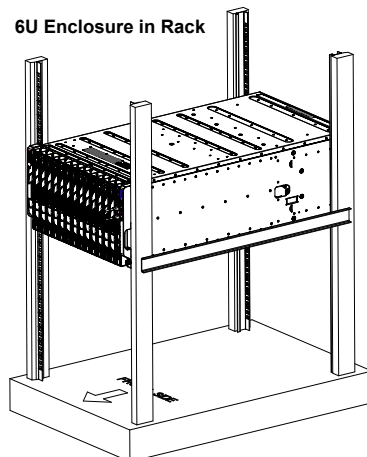

Chapter 4

System Modules

In addition to the blade units, your blade system comes equipped with one or more system modules. The modules fit into the rear of the enclosure into bays above and/or below the power supplies. This chapter describes the various blade modules that may be part of your blade system. Module configurations can be customized; you can install two of the same type module for redundancy purposes or you may omit a module altogether (except for the CMM, which is a required module). [Figure 4-1](#) and [Figure 4-2](#), along with [Table 4-1](#) and [Table 4-2](#), show typical module configuration in the 6U blade systems. See [Chapter 5](#) for information on power supply modules.

WARNING: All module bays must be populated either with a module or a dummy module cover to maintain proper airflow.

Figure 4-1. 6U SBE-614E Enclosure Rear View



Table 4-1. Typical 6U Blade System Module Configuration: Rear View

Item#	Description
1	These bays can hold any of the following: 1Gb Ethernet Switch Module, a 1/10Gb Ethernet Switch Modules or a 25G Ethernet Switch
2	CMM (Chassis Management Module)
3	2200W Power Supplies (x4 required, x4 optional depending upon system requirements); these bays can also house fan modules instead of power supplies

Figure 4-2. 6U SBE-610J Enclosure Rear View

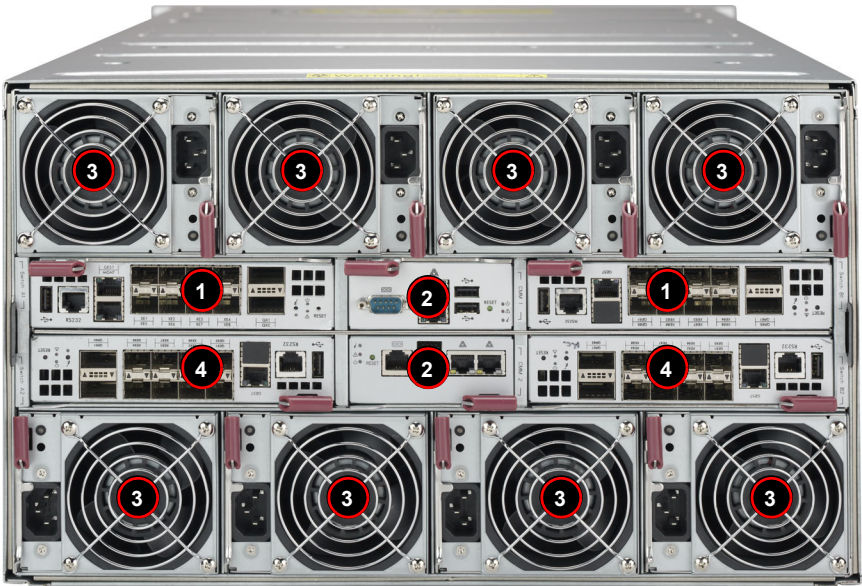

Table 4-2. Typical 6U Blade System Module Configuration: Rear View

Item#	Description
1	These bays can hold any of the following: 1Gb Ethernet Switch Module, or a 10Gb Ethernet Switch Module.
2	CMM (Chassis Management Module) (x1 standard or x2 optional per enclosure)
3	2200W Power Supplies (x4 required, x4 optional depending upon system requirements); these bays can also house fan modules instead of power supplies
4	These bays can hold a 25G Ethernet Switch.

4-1 Chassis Management Module

The Chassis Management Module (CMM) (Figure 4-3) is a required module in a blade system. This “command” module communicates with the blade units, the power supplies and the blade switches. Used in conjunction with the Web Interface or IPMI View management software, the CMM provides administrator control over individual blade units, power supplies, cooling fans and networking switches and monitors onboard temperatures, power status, voltage levels and fan speeds. The standard CMM module for the 6U SuperBlade system is the **MBM-CMM-FIO** or **MBM-CMM-001**.

NOTE: Using the MBM-CMM-FIO in the enclosure allows the use of the two front mounted RJ45 ports on the enclosure, however using the MBM-CMM-001 does not allow these ports to function.

The CMM provides a dedicated, remote KVM (keyboard/video/mouse) connection over an out of band TCP/IP Ethernet network during any server state (functioning, blue-screen, powered down, BIOS and so on). It also supports Virtual Media (VM) redirection for CD, floppy and USB mass storage devices and configures such information as the switch IP addresses. A summary of CMM features is shown in Table 4-4.

Figure 4-3. Chassis Management Module MBM-CMM-FIO

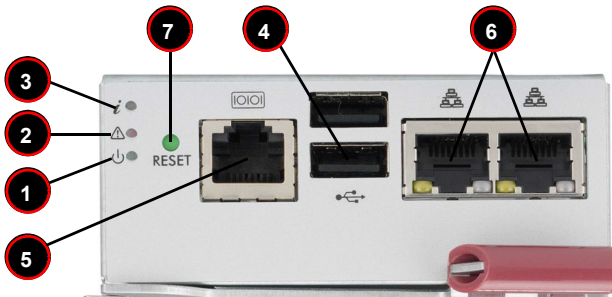

Table 4-3. MBM-CMM-FIO Module Interface

Item#	Description
1	Power LED
2	Fault LED
3	Information LED
4	USB Ports
5	IPMI Port
6	Ethernet Ports
7	Reset Button
8	Module Release Handle

Table 4-4. MBM-CMM-FIO Module Features

Feature	Description
Management Capabilities	Can manage 10 to 20 blade units, network modules and 8 power supplies
Ports	Two Ethernet ports, one IPMI Ethernet port and two USB ports (for debug only)
Basic Functions Supported	Remote KVM, remote storage, Serial-over-LAN (SOL), blade monitoring and control
System Management	System management interface provided via dedicated LAN
Power Consumption	Approximately 20W
Operating System	Firmware (upgradable)

Figure 4-4. Chassis Management Module MBM-CMM-001

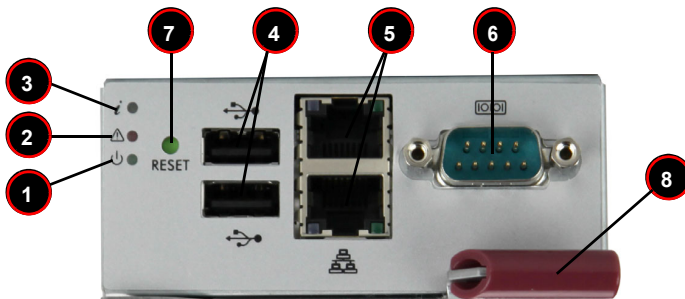

Table 4-5. MBM-CMM-001 Module Interface

Item#	Description
1	Power LED
2	Fault LED
3	Information LED
4	USB Ports
5	Ethernet Ports
6	Serial Port
7	Reset Button
8	Module Release Handle

Table 4-6. MBM-CMM-001 Module Features

Feature	Description
Management Capabilities	Manages blade units, network modules and power supplies installed in the enclosure
Ports	Two Ethernet ports, one serial port and two USB ports (for debug only)
Basic Functions Supported	Remote KVM, remote storage, Serial-over-LAN (SOL), blade monitoring and control, switch, PWS, monitor, thermal, redundant based on specific enclosure model.
System Management	System management interface provided via dedicated LAN, switch, PWS, monitor, thermal, and is redundant based on the specific enclosure model.
Power Consumption	Approximately 20W
Operating System	Firmware (upgradeable)

Module Redundancy

A blade system must have one CMM and may have two for redundancy is offered only on a specific enclosure model, which has the hardware capability to incorporate two CMM's on one backplane. Since the CMM uses its own processor, all monitoring and control functions are carried out regardless of the operation or power status of the blade units. CMM modules can only be installed in the upper and/or lower right module bays.

Determining Master/Slave Modules Status

When a blade system has two CMM modules, they are assigned a master/slave status. This is done automatically with the default primary CMM specified for per each enclosure, while there will be no redundant in certain enclosures.

If the master CMM is powered down or removed (or is being reset by its user), the second (slave) CMM module will then immediately be assigned as the master. The redundant CMM mode is only offered on specific chassis models. The slave uses the previous master IP config in case of a fail over.

NOTE: The Slave CMM keeps the same log/status as the Master CMM and uses the previous master IP config.

CMM Module Installation

Use this procedure to install the MBM-CMM-FIO or MBM-CMM-001 CMM module to the 6U SuperBlade chassis. Make sure the cover to the module has been installed before proceeding. Follow the anti-static precautions described in [Chapter 2](#).

Installing the Module:

1. Remove the dummy cover from the bay you want to place the module in.
2. Place the module's release handle in the open position.
3. Slide the module into the module bay until it stops.

4. Push the release handle to the closed position.
5. After the module has been installed and the handle locked, it will turn on and a POST test will run to verify it is working properly.

Removing the Module:

1. Pull out the release handle to the open position.
2. Pull the module out of the bay.
3. Replace immediately with another module or with a dummy module cover to maintain airflow integrity.

Configuring the CMM

To access/configure the CMM, you first have to configure the IP settings of the CMM depending on you network environment. The below procedure for this configuration just serves as a reference for getting the CMM setup. If your system has Linux OS, please follow similar instructions to get the CMM setup.

The CMM access topology is as follows:

DHCP Access:

1. Connect a network cable to the CMM module.
2. The system should boot into the default Fail Over mode. The DHCP mode will appear on the CLI mode screen.
3. If the system fail over and CLI is not active, it will proceed to the next default IP of CMM at **https://192.168.100.100**.
4. If the CMM cannot enter the default IP, then an RJ45/USB cable can be connected from the CMM's RJ45 Ethernet LAN Port to the Desktop Host using the USB Port in Serial Port mode with a speed set at 115200. The DHCP IP can be manually set at the same subnet-mask for gateway access at **192.168.100.100.01**.

Default IP Access:

1. Connect network cable to the network port at CMM.
2. At system Prompt, **https://192.168.100.100**

Requirements are:

- Computer system with LAN (RJ45) port
- RJ -45 Ethernet cable

The default IP of the CMM is **https://192.168.100.100**. Configure the Computer system (connected through Ethernet-LAN to the CMM) to the same address range (for example **https://192.168.100.101**). The default mode is the Fail Over mode. If the DHCP fails, then the CMM will automatically default to the IP address of the CMM.

Configuring the CMM in Windows OS:

1. Go to START → CONTROL PANEL → NETWORK CONNECTIONS
2. Right-click on LAN to view properties.
3. Choose “Internet Protocol (TCP/IP)” under the GENERAL tab and click on PROPERTIES (see [Figure 4-5](#)).

Figure 4-5. Choose Internal Protocol

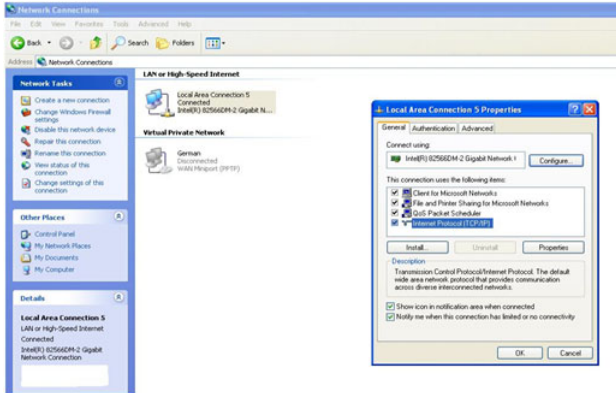

4. Manually configure the IP address of the computer system to be in the same address range as the CMM (see [Figure 4-6](#)).

Example:

- IP address: **https://192.168.100.101**
- Subnet Mask: **255.255.255.0**
- Default Gateway: **192.168.100.1**

Figure 4-6. Manually Configure the IP Address

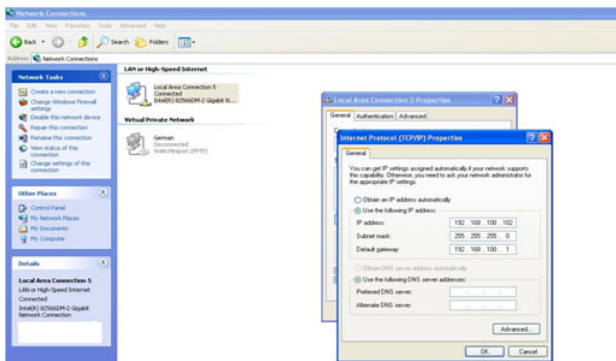

5. Once the IP address for the computer system is configured, the CMM can be accessed through the web browser by entering the default IP address **192.168.100.100** of the CMM into the browser's address bar.
6. Now, the IP address, subnet mask and default gateway of the CMM can be changed according to the network environment (see [Figure 4-7](#)). Please refer to the *Web-based Management Utility User's Manual* for more information.

Figure 4-7. Changing Settings

The screenshot shows the 'CMM Network' configuration page. At the top, there is a title 'CMM Network' with a red arrow icon. Below the title is a light blue box containing the text: 'This page you can view and modify the network settings. Select whether to obtain an IP address automatically or manually configure one.' Below this box are several input fields and radio buttons. The 'MAC Address' field is pre-filled with '0c-c4-7a-88-18-9d'. The 'Hostname' field is empty. There are three radio buttons for IP configuration: 'Obtain an IP address automatically (use DHCP mode)', 'Use the following IP address (use Static mode)', and 'Use the following IP address when DHCP fails(use Static mode when DHCP fails)'. The third option is selected. Below these are two sections for IPv4 settings. The first section, 'IPv4 Setting', has fields for IP Address (172.31.35.54), Subnet Mask (255.255.0.0), Gateway (172.31.0.1), and DNS Server IP (10.2.1.205). The second section, 'IPv4 Setting when DHCP fails', has fields for IP Address (172.31.35.54) and Subnet Mask (255.255.0.0).

WARNING: Don't change any other setting, unless you are familiar with it.

NOTE: The above screens are examples for purposes of demonstrating this procedure. The screens you actually view may or may not appear the same as those shown above.

CMM Functions

The following sections describe local functions and remote functions of the CMM. With only minor exceptions, all of the remote functions can be performed by one of three mechanisms: web-based access to the CMM module, access to the CMM using *IPMIview*, a client tool implemented in Java, or via *IPMITool* commands (DOS commands or shell scripted commands).

When the web based browser is used, the CMM acts as a web server, requiring a higher bandwidth connection to the CMM. If there are any bandwidth constraints, IPMI will provide a superior experience. Additionally, since graphical updates are provided by client-side Java, IPMIview can also be a superior user experience.

IPMITool on the other hand can provide the ability to issue similar/identical commands to many 6U SuperBlade enclosures/CMM's to manage all of them in a similar way.

Remote KVM over IP

Remote KVM over IP is independent from local KVM. Remote KVM encrypts all communication between the remote user and the CMM.

To Use: Remote KVM over IP is initiated with the management software (IPMI View or Web-based utility). Attach the LAN cable to the LAN port on the CMM module then refer to "[Web-based Management Utility](#)" on [page 4-12](#) to login and use either utility.

Remote Storage (Virtual Media)

The Remote Storage function allows the user to connect to a remote storage device (such as a floppy, hard disk, or USB storage device) and access the device as if it were local. This can be used not only to read and write to remote storage devices but to load an operating system from a remote drive.

Serial Over LAN (SOL)

Serial Over LAN allows you to redirect the input and output of a serial port via IPMI in order to manage blade modules from a remote location.

To Use: Serial Over LAN can be activated via the Web-based Management utility. See the *Web-based Management Utility User's Manual* for the procedure to initiate SOL.

Monitoring Functions

Used in conjunction with IPMI or the Web-based Management utility, the CMM module can monitor and provide information on the hardware health of the blade modules and the system as a whole. In addition to the monitoring functions, you can remotely power on, power off or reboot a system.

Health information includes:

- Temperature levels
- Fan speeds
- Voltage levels

- Power status

Power Consumption Management

The CMM module's firmware can also control all power on/off activity in the whole blade system. This is done by using the Power button, onboard BMC or from any other use of remote management software.

Once a blade module is installed in the enclosure the installed CMM immediately receives information on the rated Max Power Consumption value of the new blade module. The CMM then calculates whether there is enough power for this new blade module by comparing the Max Power Consumption value of the new blade module with the calculated Remaining Power value of the system.

If there is enough power, the CMM will power on the blade. However if there is not enough power in the blade system, then the new blade module is not powered on and the front panel LED on the enclosure will blink.

After the blade is powered on, the CMM then collects the actual power consumption of this individual blade and updates the calculated Remaining Power value for the system.

The CMM also reserves power for all the networking and chassis management modules installed on the system.

WARNING: One CMM module must be running to control the power systems and prevent overloading.

USB Ports and Reset Button

The USB Ports and Reset Button on the CMM are described below.

Figure 4-8. USB Ports on CMM

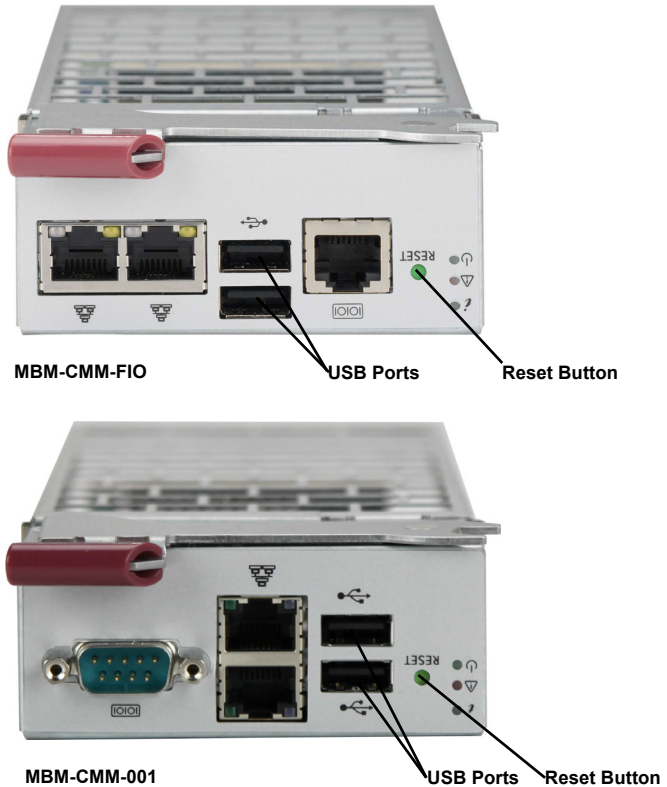

USB Ports

The USB ports on both CMM modules are shown in [Figure 4-8](#). They are only used for debugging purposes and not for communication with your system.

Reset Button

The Reset button located on the front of the CMM module is used to reset the following software settings to their defaults:

Table 4-7. CMM Reset Settings

Software Setting	Default
User Name and Password	Reset to ADMIN and ADMIN (case sensitive)
IP Address	Reset to https://192.168.100.100
Gateway Address	Reset to 0.0.0.0
Subnet Mask	Reset to 255.255.255.0

To reset the CMM to factory defaults, press and hold the Reset button for five seconds.

Firmware

The firmware for the CMM switch resides in the module. This firmware can be updated with the web-based management utility.

Within the utility, go to the MAINTENANCE > UPDATE FIRMWARE screen in the Web-based Management Utility. Here you can enter the name of the firmware you want to update or click on BROWSE to select the firmware file. Finish by clicking the UPLOAD button.

NOTE: This process is not reversible once the firmware is updated, so proceed with caution. It might take a few minutes to complete this procedure.

Web-based Management Utility

System management may be performed with either of three software packages: *IPMIview*, *SMCIPMItool* or a *Web-based Management Utility*. Any of these utilities are designed to provide an administrator with a comprehensive set of functions and monitored data to keep tabs on the system and perform management activities.

The Web-based Management Utility is a web-based interface that consolidates and simplifies system management for Supermicro 6U SuperBlade systems. The Web-based Management Utility aggregates and displays data from the CMM module.

The Web-based Management Utility provides the following key management features:

- Enables IT administrators to view in-depth hardware configuration and status information using a single intuitive interface.
- Provides an OS-independent, remote graphical console.
- Allows remote users to map local media (floppy, removable disks and hard drives) or ISO images on a shared network drive to a blade server.

Supported Browsers

The following browsers have been tested for use with the Web-based Management Utility. It is recommended that you use the most current revision of the browser you choose. The minimum browser revisions supported by the Web-based Management Utility are shown below:

- Internet Explorer 7
- Firefox 2.0.0.7
- Google Chrome

Network Connection/Login

To log into the Web-based Management Utility:

1. Launch a web browser.
2. In the address field of the browser, enter the IP address that you assigned to the system and hit the <ENTER> key.
3. When the browser makes contact with Supermicro's Chassis Management Module, enter your *username* and *password*, then click LOGIN.
4. The WEB-BASED MANAGEMENT UTILITY HOME PAGE will then display as shown in [Figure 4-9](#).

Address Defaults

[Table 4-8](#) shows the default addresses that are initially set for the CMM. Afterwards, you can change these values within the program (see the *Web-based Management Utility User's Manual M* for more details).

Table 4-8. Address Defaults

Default	Description
Default IP Address	https://192.168.100.100^a
Default Gateway Address	0.0.0.0
Default Subnet Mask	255.255.255.0
Default username	ADMIN
Default password	ADMIN

- a. **Note:** The web address must be entered as **https://192.168.100.100** in the web browser. Entering only **http://** gives you instead an address error.

Home Page

Figure 4-9 displays the WEB-BASED MANAGEMENT UTILITY HOME PAGE and its controls.

Figure 4-9. Home Page

Blade Status

Power Off | Power On | Power Cycle | Power Reset | Graceful Shutdown | AC Cycle | PwrFall Policy | Pwr Capping | ACLost Policy | Refresh

Hide >>> [Blade A2 Node 1] Summary Sensor Reading Network Config Event Log System Event Log FRU Information Date & Time Power HW Information Reset Default Configuration

Blade Status

Blade	Name	Model	Pwr Status
<input type="checkbox"/>	Blade A1		
<input type="checkbox"/>	Blade A2		On/Off
<input type="checkbox"/>	Blade A3		On/Off
<input type="checkbox"/>	Blade A4		On/Off
<input type="checkbox"/>	Blade A5		
<input type="checkbox"/>	Blade A6		
<input type="checkbox"/>	Blade A7		
<input type="checkbox"/>	Blade A8		
<input type="checkbox"/>	Blade A9		
<input type="checkbox"/>	Blade A10		
<input type="checkbox"/>	Blade B1		
<input type="checkbox"/>	Blade B2		
<input type="checkbox"/>	Blade B3		
<input type="checkbox"/>	Blade B4		
<input type="checkbox"/>	Blade B5		
<input type="checkbox"/>	Blade B6		
<input type="checkbox"/>	Blade B7		
<input type="checkbox"/>	Blade B8		
<input type="checkbox"/>	Blade B9		
<input type="checkbox"/>	Blade B10		

Node Status and Control

Location:	Blade A2 Node 1		
Board Model:	B11DPT		
Product Model:			
Blade Max Pwr:	544		
Blade Curr Power:	86		
Error:	Normal		
Part Code:	00		
BMC Version:	3.24		
CPLD Version:	02.b3.97		
BMC IP Addr:	172.31.38.95	BMC Reset	BMC Reset To Default
KVM:	Not Launched	KVM Launch	
VM:		VM Launch	
SOL:		SOL Launch	
Blade UID:	Off	UID Off	UID On
Name:		Save Name	
PwrFall Policy:	Throttle	Save PwrFall Policy	
Pwr Status:	On	Power Off	Power On
		Reset	Power Cycle
			Graceful Shutd

NOTE: For more information on the Web-based Management Utility, and a description of its controls, see the *Superblade Web-based Management Utility User's Manual* for more details.

Chapter 5

Power Supply Modules

The 6U SuperBlade enclosure comes standard with one CMM module (see the [Chapter 4](#) for details on the CMM module) and either two or four power supplies. See [Appendix A](#) for summary specification details on the power supplies available to the 6U SuperBlade enclosure.

5-1 Power Supply Modules

The minimum amount of modules required to power the system depends upon the full complement of blade units installed into an enclosure and the type of switches installed in the enclosure. An LED on the back of a power supply will be amber when AC power is present and green when the power is on.

When installing only a few power supplies in the enclosure, they should be installed first in the lower rather than the upper power bays. This is to provide increased airflow across the memory modules within each blade module.

The 2200W power supply modules require a 200-240V AC input and a C13 socket, which requires a power cord with a C14 connector.

Supermicro's high-efficiency blade system power supplies deliver continuous redundant power up to 94% peak efficiency. Each power supply module includes a management module that monitors the power supplies and the power enclosure

The features of these power supplies are shown below.

Table 5-1. Amperage Draw Specifications for the PWS-2K21A-BR Power Supply

Watts	Low Volts	High Volts	Low Amps	High Amps
1200W	100	127	11	14
1980W	220	230	9.8	10
2090W	230	240	9.8	10
1800W	200	220	9.5	10
2200W (UL/cUL only)	220	240	11	12
2090W (UL/cUL only)	180	220	11	14

Figure 5-1. PWS-2K21A-BR Power Supply



Table 5-2. PWS-2K21A-BR Power Supply Features

Feature	Description
Output	2200W/2090W/1980W/1800W/1200W
Type	Redundant Module (N+1/N+N)
+12V	183.33A (2200W), 174.17A (2090W), 165A (1980W), 150A (1800W) or 100A (1200W)
+12VSB	2A
PFC	Yes
Peak Efficiency	96%+ (Titanium Level)
Input AC Range	100-127V (1200W), 200-220V (1800W), 220-230V (1980W), 230-240V (2090W), 200-220V (2090W for UL & cUL) or 220-240V (2200W for UL & cUL)
Operating Conditions	Temp: 0 to 50 C Humidity: 5 to 95% RH
Fan Type	80x80mm counter rotating fan
Dimensions (LxWxH)	245.3 x 106.5 x 84mm

Figure 5-2. PWS-1K20B-BR Battery Backup Power Module



Table 5-3. PWS-1K20B-BR Battery Backup Power (BBP) Module Specifications

Feature	Description
Total Output Power	1200W
Input	11.2 to 12.9VDC
Output	12V, 12VSB
Form Factor	MicroBlade
Dimensions	245.3 x 106.5 x 84-mm
Battery Cell Capacity	68W/hr
Redundant	N+1, N+N
I ² C Remote Monitoring	FRU/Smart Battery I ² C
+12V Output	100A
12VSB Output	2.5A
Efficiency	Online mode battery power consumption less than 5W
Discharge Duration	1200W for 35 Seconds
Cell Chemistry	Lithium-Ion
Cooling	Internal 80 x 80-mm colling fan
Operating Temperature	5°C - 50°C

Table 5-4. PWS-1K20B-BR BBP Module Estimated Runtime

Power Load	Installed BBP Modules	Discharge Duration
1000W	4	180 Seconds
2000W	4	120 Seconds
3000W	4	60 Seconds
4000W	4	35 Seconds
4800W	4	35 Seconds

Under typical conditions, the above is the estimated runtime for the BBP modules. The runtime can be extended by adding additional BBP modules to a system.

Table 5-5. Chassis Compatible with the BBP

Model	Output Power	Capacity	SBE-614EB-422	SBE-610JB-422
PWS-1K20B-BR	1200W	68W/hour	Up to 4	Up to 4

Power Supply Failure

If a power supply or a fan in a power supply fails, the system management software will notify you of the situation. In either case, you will need to replace the power supply module with another identical one.

NOTE: Refer to www.supermicro.com/products/superblade for possible updates on part numbers.

Installing a Power Supply

1. Insert a replacement unit into the empty power bay with the handle to the left.

WARNING: This left/right orientation depends on the power supply's top or bottom location. If you inadvertently put a power supply upside down in the lower slots, it can be VERY difficult to remove the power supply.

2. Push unit all the way in until it is firmly seated.
3. Push the handle back into the closed position until it clicks into the locked position.
4. Move the locking clip away from the socket and reconnect the power cord.

Removing a Power Supply

First, make sure the power supply has been shut down. You can remove power from a power unit via your system management software.

1. Remove the power cord from the power supply unit.
2. Release the locking clip to unlock the power supply module.

- Pull out the handle and remove the unit: the two-piece handle locks into the closed position. To release the handle, squeeze together the two metal plates of the handle with your thumb and fingers and then pull out.

5-2 Redundant Power Supplies

Each blade enclosure can hold up to eight (SBE-614E) power supplies. Installing the maximum number of power supplies may provide you with redundant power – depending upon the number of blades in the enclosure, the model and power level of the power supplies installed and the power load from modules in your system. In most blade enclosure systems power supplies may be redundant and therefore provide backup in case of power supply failure. The configuration for power redundancy is created using the IPMIView application tool for the system.

For purposes of denoting the amount of redundancy, a server system has N main power supplies to support the whole system working, with a “+” number after the N denoting the number of redundant power supplies. Hence, if there is one power supply for redundancy in a system that has the feature of “redundant power”, the total of power supplies for that server system is denoted as $N+1$.

For example, suppose a system has four 2200 Watt Power Supply Units (PSU), for a total power supply of 8800 Watts. The maximum power usage of each blade is 375 Watts for a total power demand of 3750 Watts to run the whole system. So in this example there are effectively two redundant power supplies ($N+1$) over what is needed to power the blades in the system.

In the IPMIView tool you can set the priority (default CPU power usage) of each blade first before any PSU fails (0% -> shut down, 50% -> throttling, 100% -> Running). See [Figure 5-3](#) below for an example.

Figure 5-3. Power Supply Status

Power Supply

[Refresh](#)

Power Supply

Pwr Supply	Model Name	Pwr Status	Temperature	Fan Speed(RPM)	Input Voltage	Max Watt	Input Current	DC Output Current	Cur Pwr Usa
Power Supply A1	PWS-2K21A-BR		29 C	4809	208 V	2200 W	0.44 A	3 A	1.64%
Power Supply A2	PWS-2K21A-BR		29 C	4923	207 V	2200 W	0.44 A	4 A	2.18%
Power Supply A3	PWS-2K21A-BR		40 C	4809	206 V	2200 W	0.44 A	3 A	1.64%
Power Supply A4	PWS-DF006-2F		--	5496	--	--	--	--	--
Power Supply B1	PWS-2K21A-BR		29 C	4923	208 V	2200 W	0.50 A	3 A	1.64%
Power Supply B2	PWS-2K21A-BR		29 C	4923	207 V	2200 W	0.44 A	3 A	1.64%
Power Supply B3	PWS-2K21A-BR		28 C	4923	207 V	2200 W	0.44 A	3 A	1.64%
Power Supply B4	PWS-DF006-2F		--	5496	--	--	--	--	--
FAN C1									
FAN C2									
FAN C3									

Power Consumption

Total Power	Blade Power Reserve	Peripheral Power Reserve	Available Power	Power Consumption	Current Maximum Temperature
13200 W	1503 W	520 W	11177 W	555 W	66.C/150.80.F on Blade A2

Blade Power Reserve - the power wattage reserved for the blade motherboard.
Peripheral Power Reserve - the power wattage reserved for the peripheral (e.g. Gigabit/InfiniBand Switch).

Power Supply Redundancy Policy

Redundancy Option:
 Redundancy N+1
 Redundancy N+N

Power Supply Fan Speed Control Option

Fan Control Option:

Therefore the following redundancies apply to your system when, as an example, 2200W power supplies fail.

- If one PSU fails, then you have 6600 Watts available. The CMM will detect the remaining power left for the whole system. But because the total blade power usage is only 3750 Watts, every blade can still work properly.
- If 2 PSUs fail, then only 4400 Watts are left available to support the blade power usage. The system can still support all ten blades running in it.
- If 3 PSUs fail, then the remaining 2200 Watts available cannot support the whole system. Therefore the CMM will start to shut down or throttle down the load in order to keep blades running based upon the priority settings that were made for each blade using the IPMIView application until the load is enough to power the remaining blade modules.

5-3 Power Supply Fans

Each power supply unit has two to four rear fans. These fans are not hot-swappable. If one fails, the power supply will continue to operate but you should replace the power supply unit at the earliest opportunity. If two or more fans fail, the power supply unit will shut down and the LED on the back will turn amber.

Appendix A

System Specifications

A-1 Enclosure Specifications

NOTE: Up to 8x (N+1 or N+N redundant) 2200W Titanium certified (96% efficiency) AC power supplies or 2000W DC power supplies battery back-up option PDU are required for an enclosure.

Table A-1. 6U Enclosure Specification Features

Enclosure	SBE-614E rack mount blade enclosures Dimensions: (WxHxD) 10.5" x 17.6" x 32" (266.7 x 447 x 812.8 mm)
Blade Module Support	Up to either 14 one or two-socket hot-plug blade servers
System Cooling	Eight PWM fans in the rear chassis. In addition, up to six (6) optional cooling fan modules can be used in place of four power supplies can be mounted in an enclosure.
Power Supplies (modules required varies)	Rated Output Power: 2200W (Part# PWS-2K21-BR, C-14 type socket) power supplies Rated Output Voltages: +12V (183A), +12Vsb (2A) for 2200W; +12V (174A), +12Vsb (2A) for 2090W; +12V (165A), +12Vsb (2A) for 1980W; +12V (150A), +12Vsb (2A) for 1800W; +12V (100A), +12Vsb (2A) for 1200W Power Supply Model Numbers: <ul style="list-style-type: none"> • PWS-2K21A-BR • PWS-DF006-2F
System Input Requirements	AC Input Voltage: 220~240V AC auto-range for 2200W; 230~240V AC auto-range for 2090W; 220~230V AC auto-range for 1980W; 200~220V AC auto-range for 1800W; 100-127V AC auto-range for 1200W Rated Input Current: 12A-11A for 2200W; 14-11A for 2090W; 10-9.8A for 1980W; 10-9.5A for 1800W; 14-11A for 1200W Rated Input Frequency: 50 to 60 Hz
Thermal Range	Supermicro's new 6U SuperBlade Enclosure has a wide thermal support range to incorporate a significant range of CPU TDP, this can range from 85W, 105W, 125W, 130W, 140W, 150W, 155W, 165W and 205W. A special heatsink is required for the gold CPU with TDP ranging from 165W-200W. Extra wide heatsinks are required for the 205W platinum CPU. For further details, please check with thermal specifications and advisory for conditional thermal support of 15-32° degree ambient and 10-35° degree ambient temperatures. The 6U system will not support 5-45° degree ambient temperatures.

A-2 Environmental Specifications

Table A-2. Environmental Specification Features

Operating Environment	Operating Temperature: 10° to 35° C (50° to 95° F)
	Non-operating Temperature: -40° to 70° C (-40° to 158° F)
	Operating Relative Humidity: 8% to 90% (non-condensing)
	Non-operating Relative Humidity: 5 to 95% (non-condensing)
Regulatory Compliance	Electromagnetic Emissions: FCC Class A, EN 55022 Class A, EN 61000-3-2/-3-3, CISPR 22 Class A
	Electromagnetic Immunity: EN 55024/CISPR 24, (EN 61000-4-2, EN 61000-4-3, EN 61000-4-4, EN 61000-4-5, EN 61000-4-6, EN 61000-4-8, EN 61000-4-11)
Safety	EN 60950/IEC 60950-Compliant, UL Listed (USA), CUL Listed (Canada), TUV Certified (Germany), CE Marking (Europe) California Best Management Practices Regulations for Perchlorate Materials: This Perchlorate warning applies only to products containing CR (Manganese Dioxide) Lithium coin cells. "Perchlorate Material-special handling may apply. See www.dtsc.ca.gov/hazardouswaste/perchlorate for details.

A-3 Address Defaults

Table A-3. Address Defaults

CMM Module	IP Address: 192.168.100.100
	Gateway Address: 0.0.0.0
	Subnet Mask: 255.255.255.0
	User Name and Password: ADMIN and ADMIN (case sensitive)
GbE Switch	IP Address: 192.168.100.102
	Gateway Address: 192.168.100.1
	Subnet Mask: 255.255.255.0

A-4 Power Supply Power Calculations

Table A-4. Power Supply: Power Calculations (PWS-2K21A-BR)

Calculation	Value
Watts	2200
Volts (High/Low)	240/220
Amps (High/Low)	12/11
Efficiency (High)	96%
Power Factor (High)	98%
10% Reserve (High)	1.5
10% Reserve (Low)	1.3
Amps (Total)	11@240 volts

Table A-5. Power Supply: Power Calculations (PWS-1K20B-BR)

Calculation	Value
Watts	1200
Volts (High/Low)	DC Output 12V: 12Vsb DC Input: 11.2 to 12.9Vdc
Amps (High/Low)	+12V Output: 100A 12Vsb Output: 2A
Efficiency (High)	94%
Power Factor (High)	98%
10% Reserve (High)	1.5
10% Reserve (Low)	1.3

Disclaimer

The products sold by Supermicro are not intended for and will not be used in life support systems, medical equipment, nuclear facilities or systems, aircraft, aircraft devices, aircraft/emergency communication devices or other critical systems whose failure to perform be reasonably expected to result in significant injury or loss of life or catastrophic property damage. Accordingly, 6U SuperBlade disclaims any and all liability, and should buyer use or sell such products for use in such ultra-hazardous applications, it does so entirely at its own risk. Furthermore, buyer agrees to fully indemnify, defend and hold Supermicro harmless for and against any and all claims, demands, actions, litigation, and proceedings of any kind arising out of or related to such ultra-hazardous use or sale.